

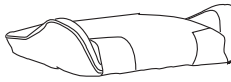

(O tamanho das peças pode variar de acordo com o modelo)

<p>A</p> 	<p>B</p> 	<p>C</p> 	<p>D</p> 
<p>Encosto: 1pc</p>	<p>Assento: 1pc</p>	<p>Mecanismo: 1pc</p>	<p>Apoio para Braços: 1 par</p>
<p>E</p> 	<p>F</p> 	<p>G</p> 	<p>H</p> 
<p>base x 1</p>	<p>Rodízios: 5pcs</p>	<p>Pistão a gás: 1pc</p>	<p>Capa protetora: 1pc</p>
<p>I</p> 	<p>J K</p> 	<p>L M</p> 	<p>N</p> 
<p>Chave Allen x 1</p>	<p>J- Parafusos 6*20mm x 4 K- Parafusos 8*25mm x 8</p>	<p>L- Parafusos 6*30mm x 6 M- Parafusos 5*10mm x 6</p>	<p>Suporte x1</p>
<p>O</p> 	<p>P</p> 	<p>Q</p> 	<p>R</p> 
<p>Suporte x1</p>	<p>Capa protetora x 2</p>	<p>Encosto de cabeçax 1</p>	<p>Encosto das costas x 1</p>

Cadeira Gamer G700

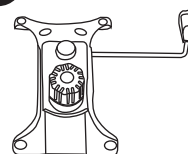
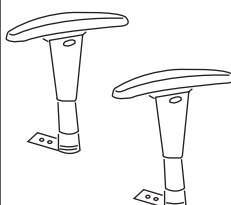
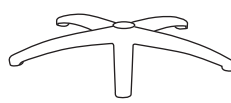
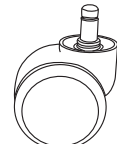
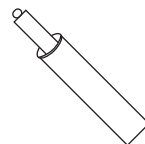
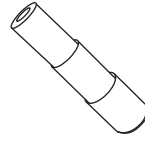
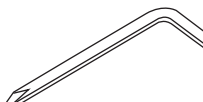
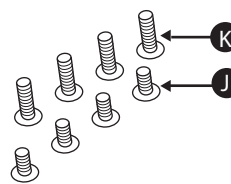
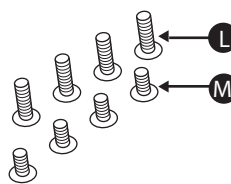
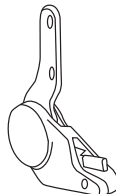

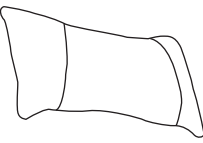
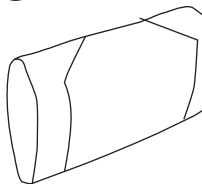
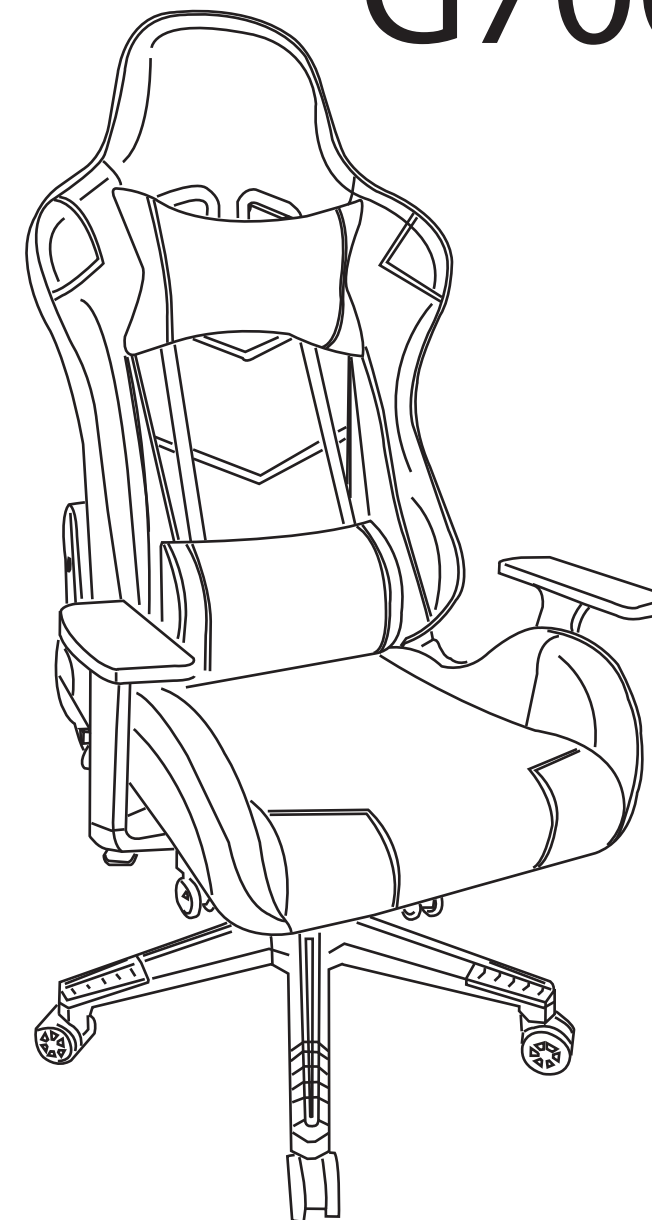
Por favor, fique atento as instruções básicas de segurança.



1. A cadeira consegue suportar o peso de apenas uma pessoa.
2. Por favor, usar o produto em um piso nivelado.
3. Não é aconselhável que crianças menores de 5 anos sentem sozinhas na cadeira.
4. Por favor, nunca sente no apoio de braços.
5. Nunca ficar em pé sobre a cadeira.
6. Não colocar objetos pesados sobre o assento ou utilizá-la como carrinho.
7. Não colocar o dedo dentro do mecanismo.

Manual do Usuário

GUIA DE MONTAGEM

G700

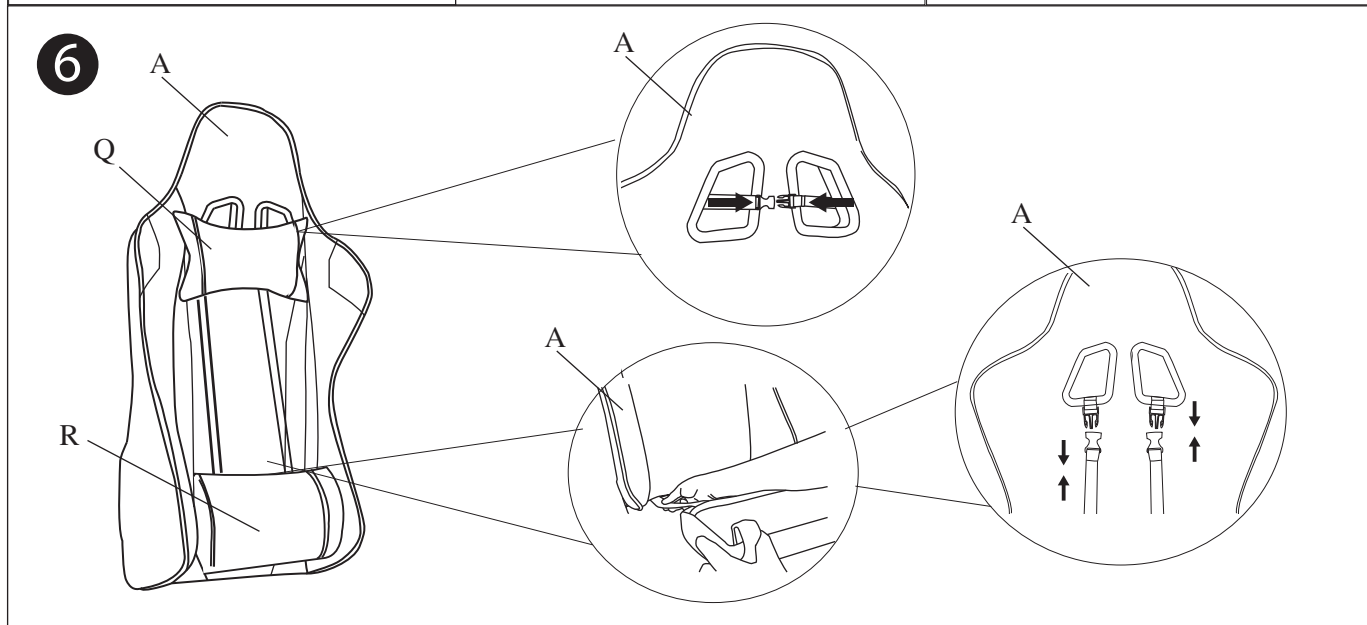
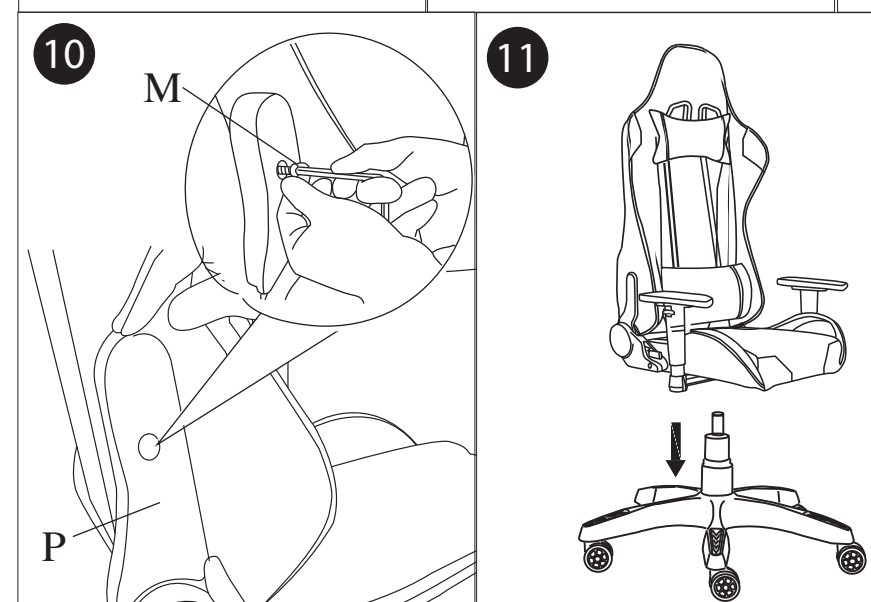
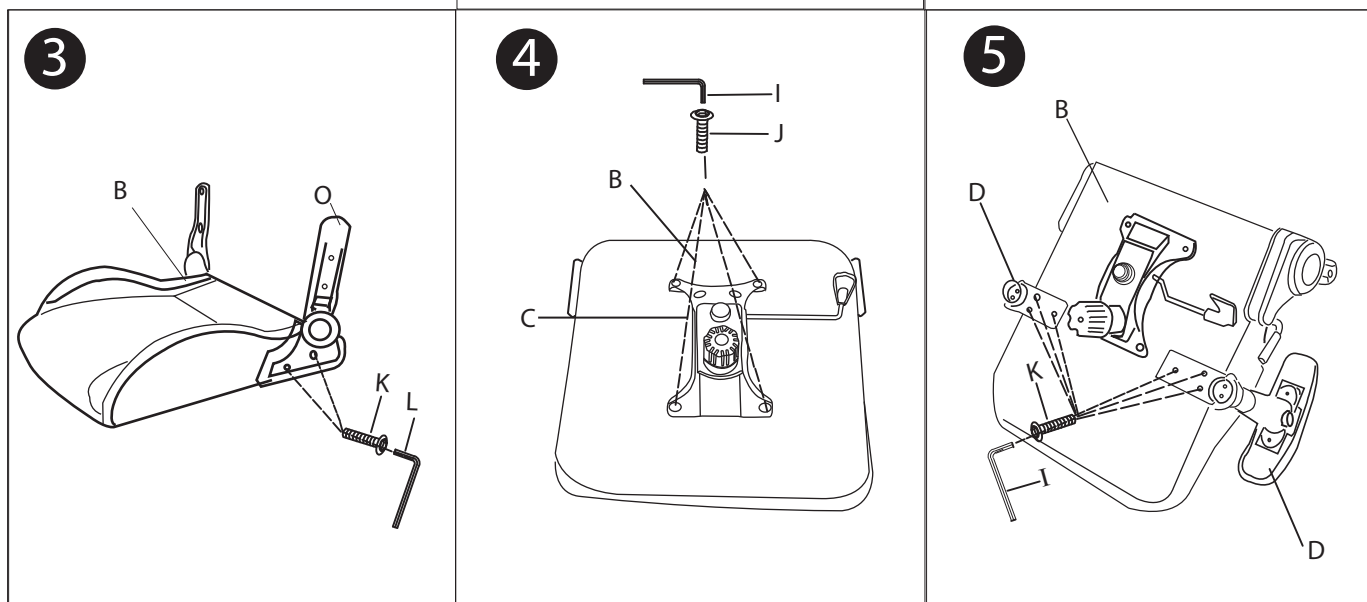
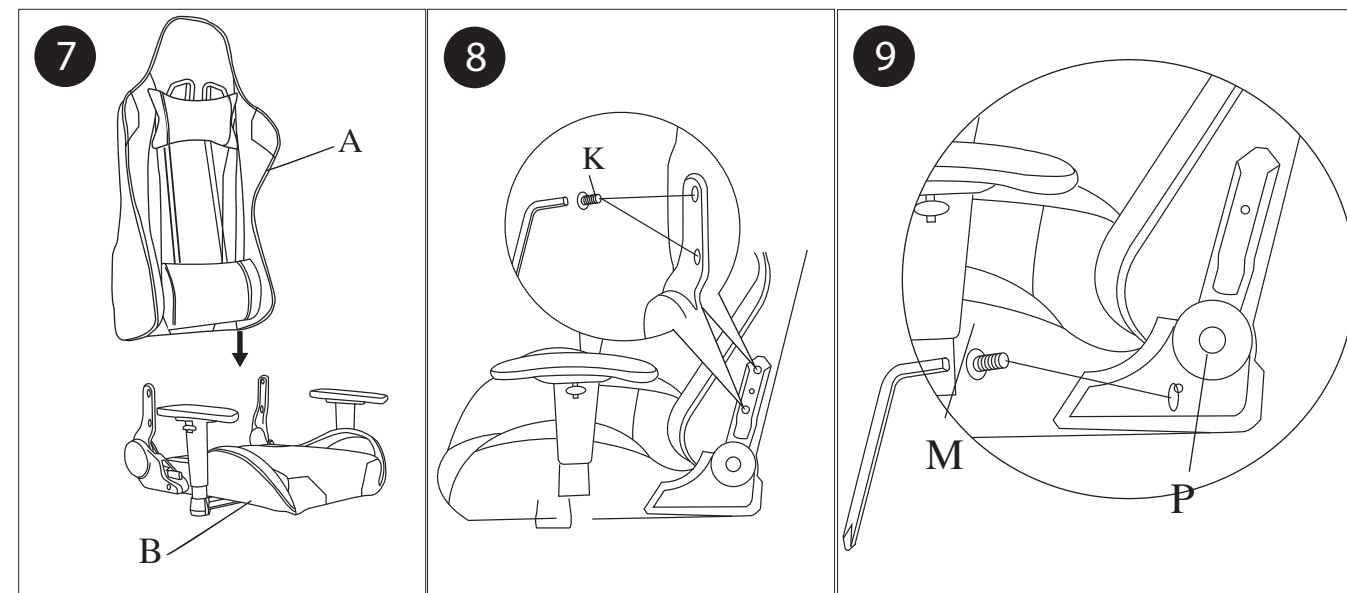
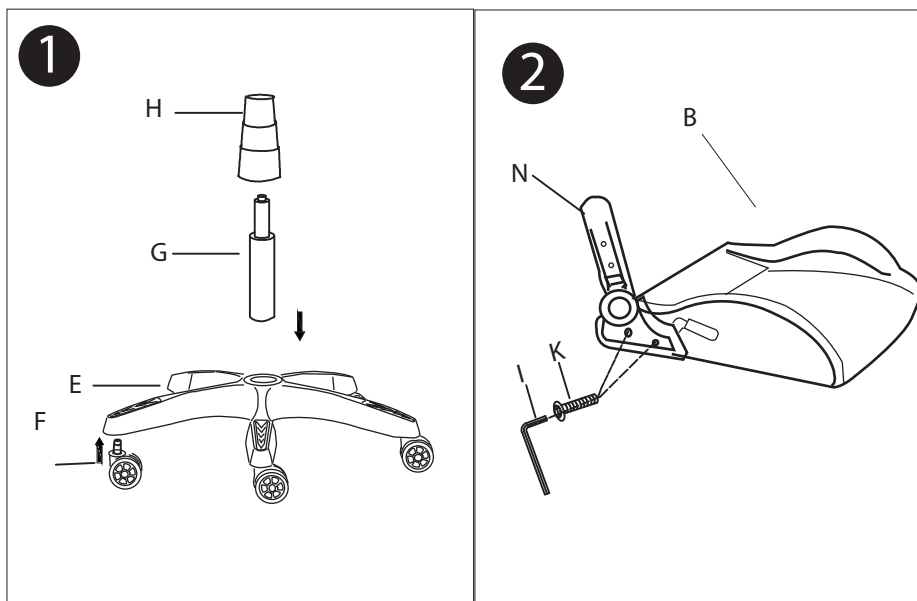

Cadeira Gamer G700

